

SIDE VIEW TOP VIEW

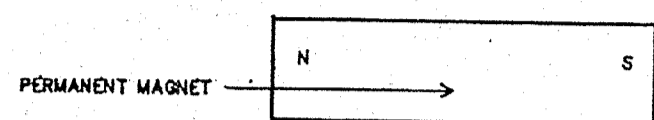

FRONT VIEW

50 P# M001 (# OF: 17)

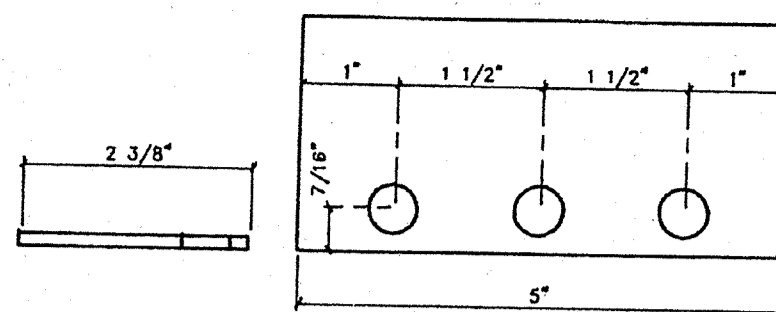

SIDE VIEW TOP VIEW

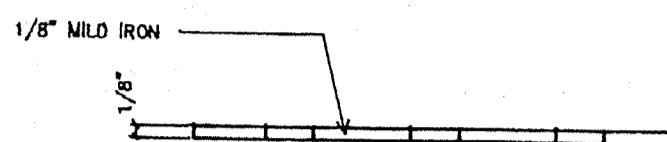

FRONT VIEW

FIG. 51 P# E002 (# OF: 17)

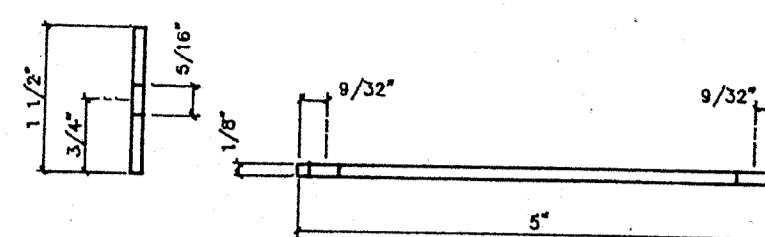

SIDE VIEW TOP VIEW

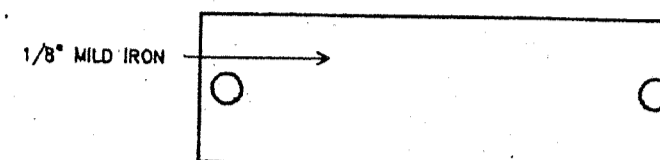

FRONT VIEW

FIG. 52 P# E003 (# OF: 17)

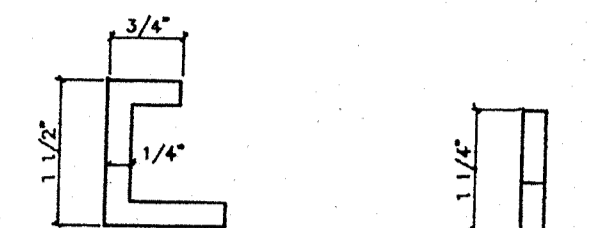

SIDE VIEW TOP VIEW

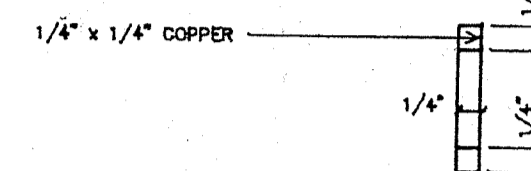

FRONT VIEW

FIG. 53 P# CS005 (# OF: 34)

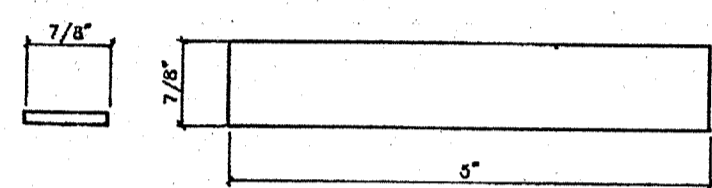

SIDE VIEW TOP VIEW

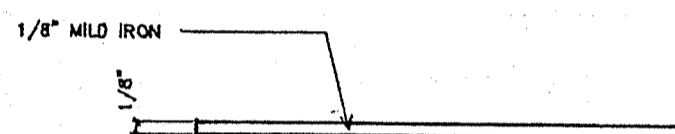

FRONT VIEW

P# E004 (# OF: 17)

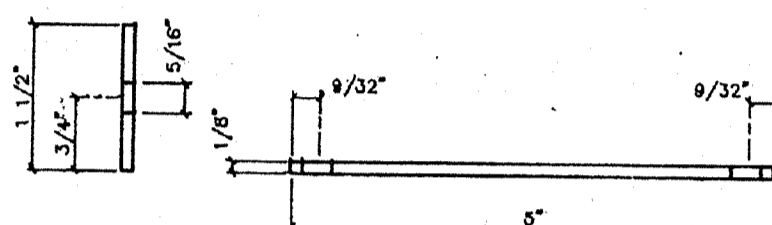

SIDE VIEW TOP VIEW

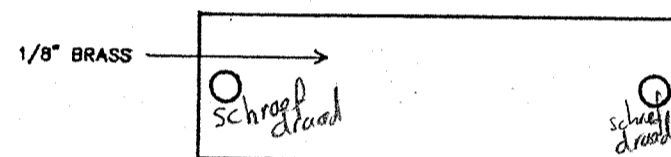

FRONT VIEW

FIG. 55 P# E006 (# OF: 17)

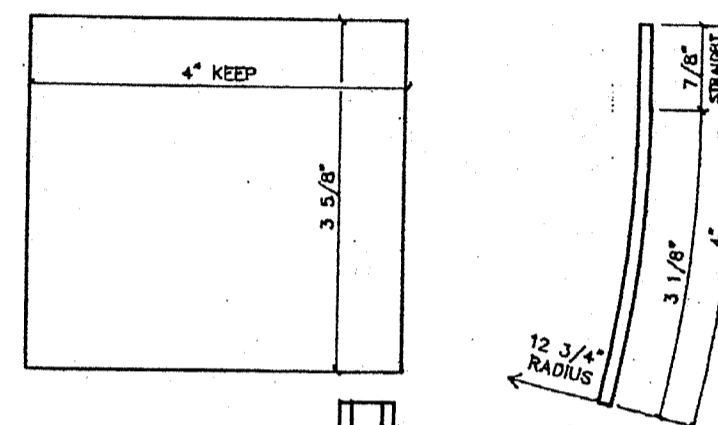

SIDE VIEW TOP VIEW

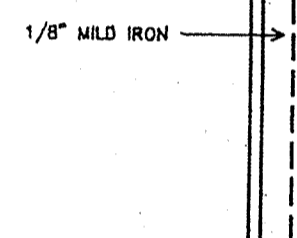

FRONT VIEW

FIG. 56 P# K009A (# OF: 11)

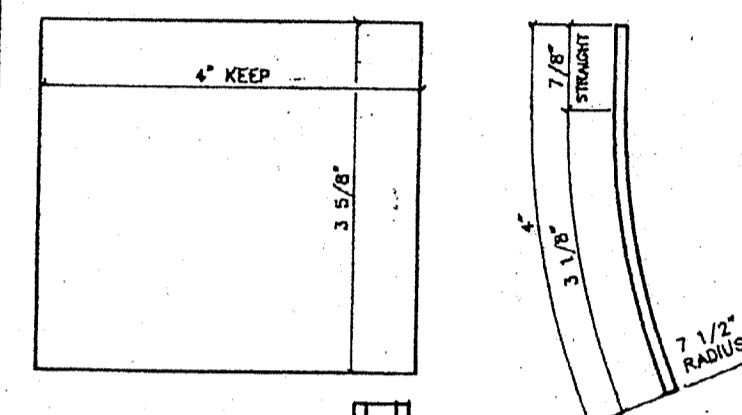

SIDE VIEW TOP VIEW

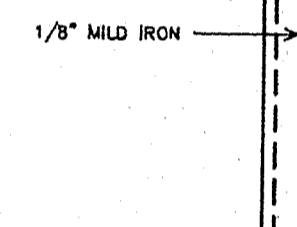

FRONT VIEW

FIG. 57 P# K009B (# OF: 6)

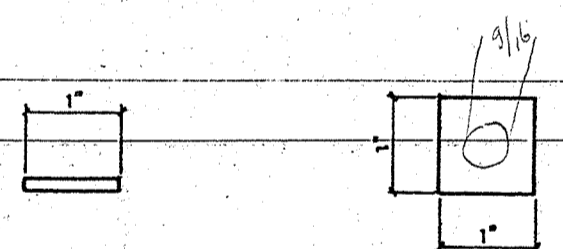

SIDE VIEW TOP VIEW

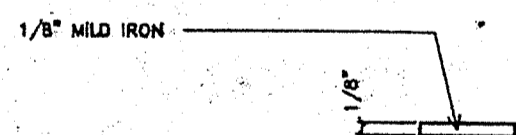

FRONT VIEW

P# E012 (# OF: 17)

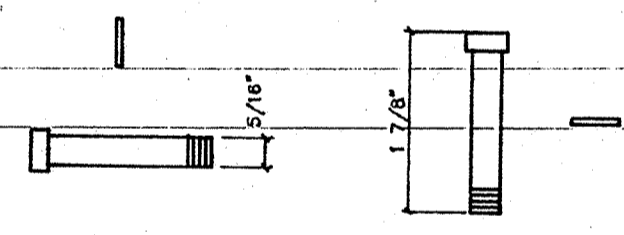

SIDE VIEW TOP VIEW

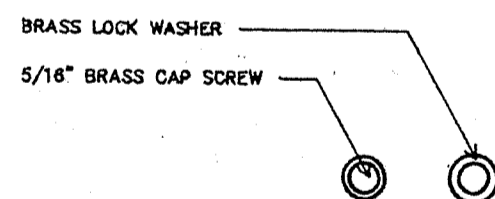

FRONT VIEW

FIG. 59 P# W007 / P# S008 (# OF: 34 EA.)

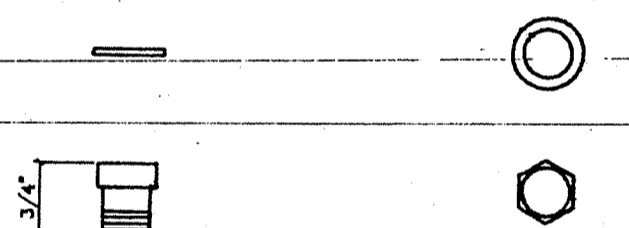

SIDE VIEW TOP VIEW

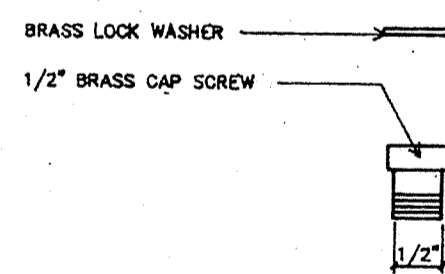

FRONT VIEW

FIG. 60 P# W010 / P# S011 (# OF: 68 EA.)

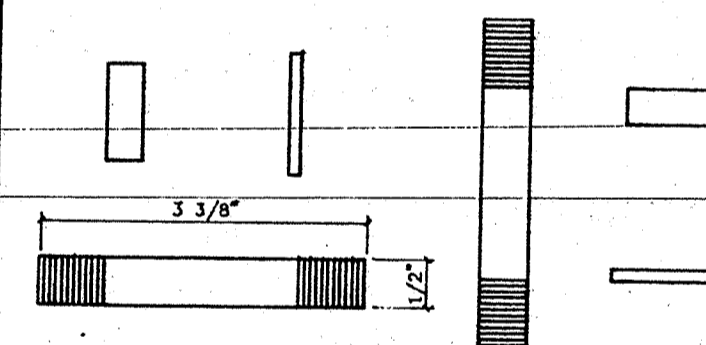

SIDE VIEW TOP VIEW

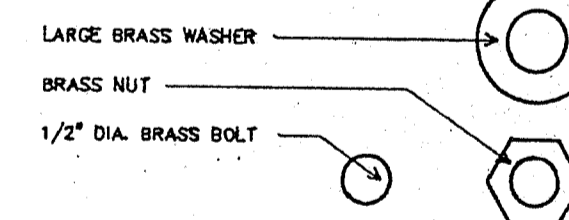

FRONT VIEW

FIG. 61 P# B020 (# OF: 6 EA.) / P# W021 / P# N022 (# OF: 24 EA.)

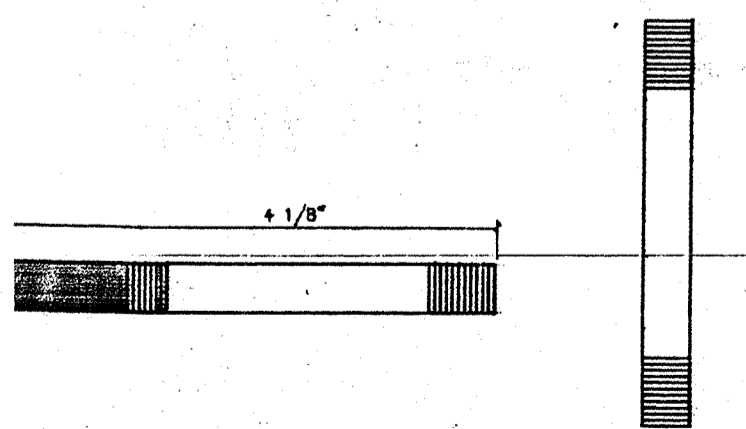

SIDE VIEW TOP VIEW

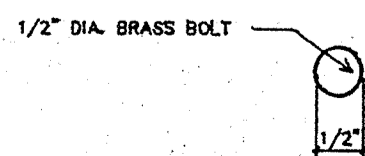

FRONT VIEW

P# B029 (# OF: 6)

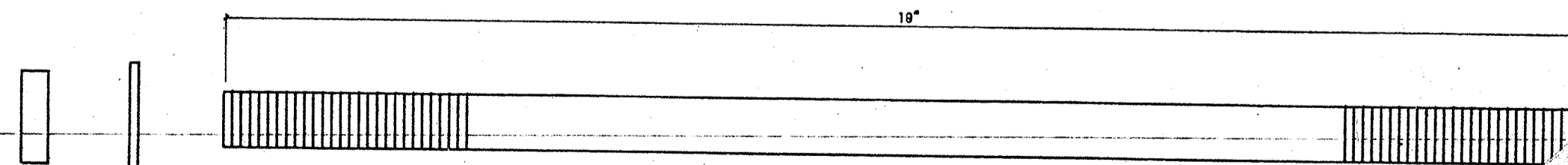

TOP VIEW

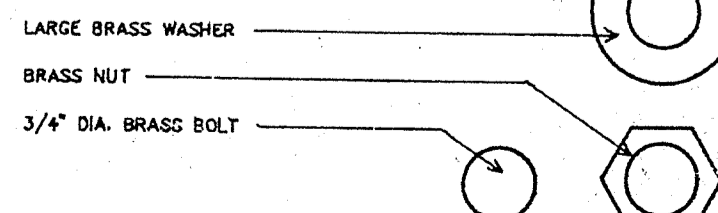

FRONT VIEW

FIG. 63 P# B034 (# OF: 7) / P# W035 / P# N036 (# OF: 14 EA.)